

MAGNATEX[®]

Pumps, Inc.

“when leakage is not an option”



MAXP Series

“After 12 years, a large chemical producer in Texas finally called for repair parts. This 60 HP driven pump had been pumping 500° F heat transfer oil at 700 GPM with no down time (over 100,000 hours). The customer admitted to making a mistake which caused the pump to run dry and require repair; however, they were extremely pleased with the pump’s performance. “

MAXP Series Magnetically Driven, Sealless, ANSI Centrifugal Pumps

The Magnatex MAXP Series pumps meet all of the ANSI B73.3 requirements in both liquid and drive-end. Its rugged construction and proven design features make it the ideal pump for use in installations handling toxic, noxious or corrosive liquids where leakage to the atmosphere is not an option.

The MAXP Series is available in 17 pump sizes, 16 magnet sizes and 9 different alloy materials of construction. With capacities to 2000 GPM, heads to 470 FT, 200 HP and temperatures to 750° F, the MAXP pump can handle a broad range of difficult applications.

MAXP series benefits include:

- Full ANSI interchangeability
- Secondary containment
- Broad performance range
- Back pull-out design

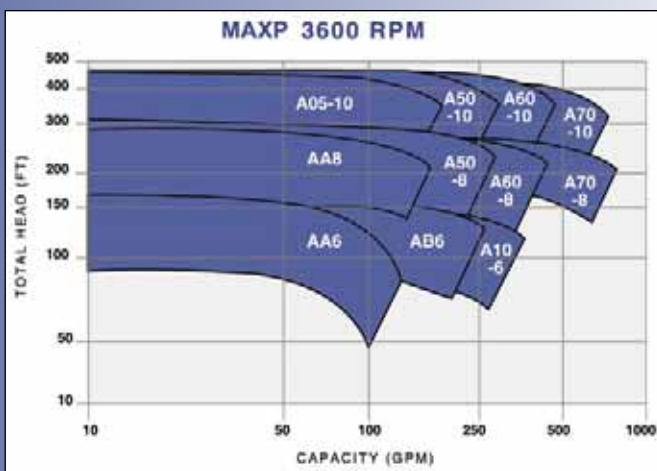
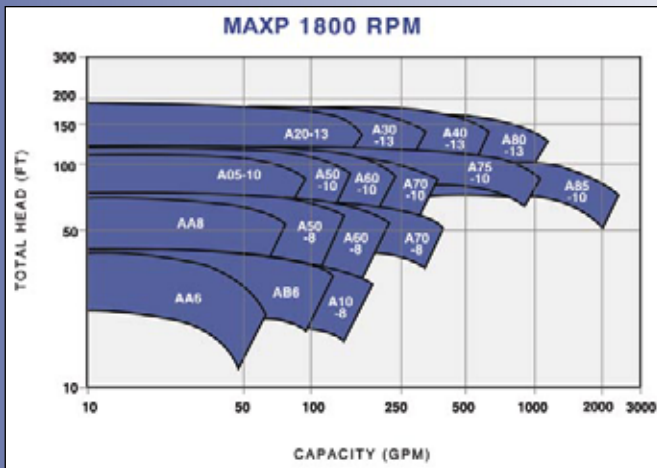

MAXP Specifications

Maximum Flow	2000 GPM
Maximum Head	470 FT
Temperature	-150° to 750° F
Maximum Power.....	200 HP
Working Pressure	285 PSIG
Materials of Construction.....	304, 304L, 316, 316L SS, Monel, Alloy 20, Hastelloy C
Connections	150 or 300 LB RF
Bearings	Silicon Carbide
Impeller.....	Enclosed
Speeds	1800/3600 RPM
Magnets.....	Neodymium or Samarium Cobalt
Motor	“T” Frame
Secondary Containment.....	Optional
Steam Jackets.....	Optional
External Flush & Vent.....	Optional

MPL/MP Series

MPL/MP Series Magnetically Driven, Seal-less, Close-Coupled Centrifugal Pumps

Compact Magnatex MPL/MP Series pumps are the efficient and dependable, choice for medium-flow, high-head applications. Rare earth Neodymium magnets make the difference: synchronous drive with no slippage and less internal heat than other magnetic drive pumps for cooler running and longer life. And the attraction doesn't end there. With 13 models to choose from in 316 SS, Alloy 20 or Hastelloy C construction, there's an MPL/MP Series pump to meet exact application requirements.

Magnatex MPL/MP Series pumps offer outstanding features for unbeatable performance:

- Straddle-mounted, double-bearing design reduces shaft load and bearing wear over typical cantilevered, overhung designs
- Slip fit construction allows easy maintenance and on-site repairs
- Larger internal flow path handles solids: 1% at 500 microns; 8% at 100 microns
- Close-coupled configuration eliminates alignment of coupling and motor, etc.
- Provides hydraulic operation closer to BEP for low flow applications



- Pricing comparable to mechanical sealed pumps
- Product-lubricated Silicon Carbide bearings don't require maintenance or additional lubrication
- No expensive mechanical seals: eliminates costly shutdowns and pump repairs
- Handles toxic, noxious and corrosive liquids for leak-free pumping with increased safety to plant personnel and the environment
- MPL Series - process side conforms to ANSI B73.3 dimensions
- MP Series sub-ANSI sizes for efficient lower flow applications

“A very narrow range of pumpable temperatures for 55% formaldehyde was a big headache for one of the midwest's largest chemical plants. Too hot and unwanted formic acid was formed; too cold and formalin precipitated out. Either way, the mechanical seals on existing pumps fell victim and noxious, dangerous odors were emitted from the pumps. Finally, Magnatex MP pumps solved the problem through uniform-temperature pumping and no leak path for fumes.”

MPL/MP Specifications

Maximum Flow	340 GPM
Maximum Head	400 FT
Temperature	-100° to 300° F
Maximum Power.....	20 HP
Working Pressure.....	225/150 PSIG
Materials of Construction.....	316 SS, Alloy 20, Titanium, Hastelloy C
Connections	150 LB RF
Bearings	Silicon Carbide
Impeller.....	Enlosed
Speeds	1800/3600 RPM
Magnets.....	Neodymium
Motor	“C” Face

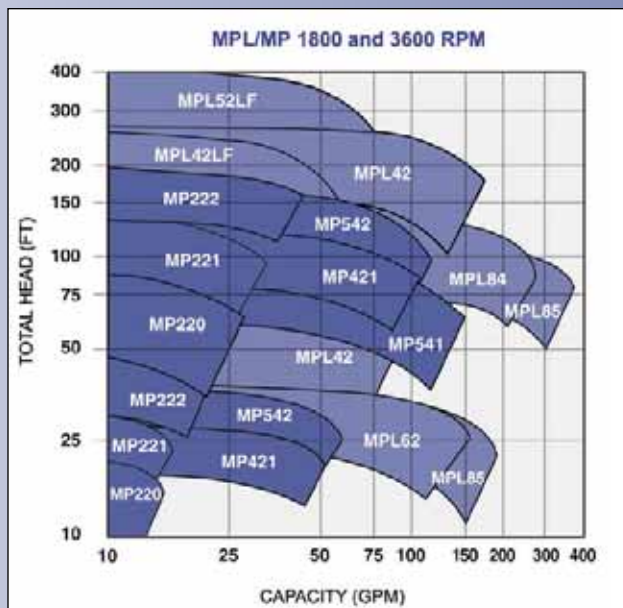

Magnatex[®] Proven Technology

Advanced Design Features

Magnatex design magnetic drive pumps were first introduced in the early 80's in response to the process industry's growing concern for the environment, the safety of plant personnel and the high ongoing cost of mechanical seal maintenance. Since then, thousands of these rugged, dependable pumps have been successfully installed worldwide. Proven design features include:

- Inner magnet assembly straddle-mounted between dual Silicon Carbide bearings
- Neodymium or Samarium Cobalt rare-earth magnets
- Oversized internal and external magnet clearances
- Replaceable shaft sleeves

- Slip-fit construction
- Fully drainable front and rear casings
- Single static gasket construction

Magnatex pumps are constructed with a minimum number of parts and are easy to disassemble and reassemble on-site without special tools or skills. Easy accessibility to all bolt heads is standard on Magnatex pumps for ease of maintenance. Magnatex pumps incorporate several advanced design features including optional secondary containment and provisions for a thermocouple and vibration monitoring equipment.

The advanced engineering of Magnatex pumps assures you of the ultimate in lead-free, maintenance-free pumping technology.

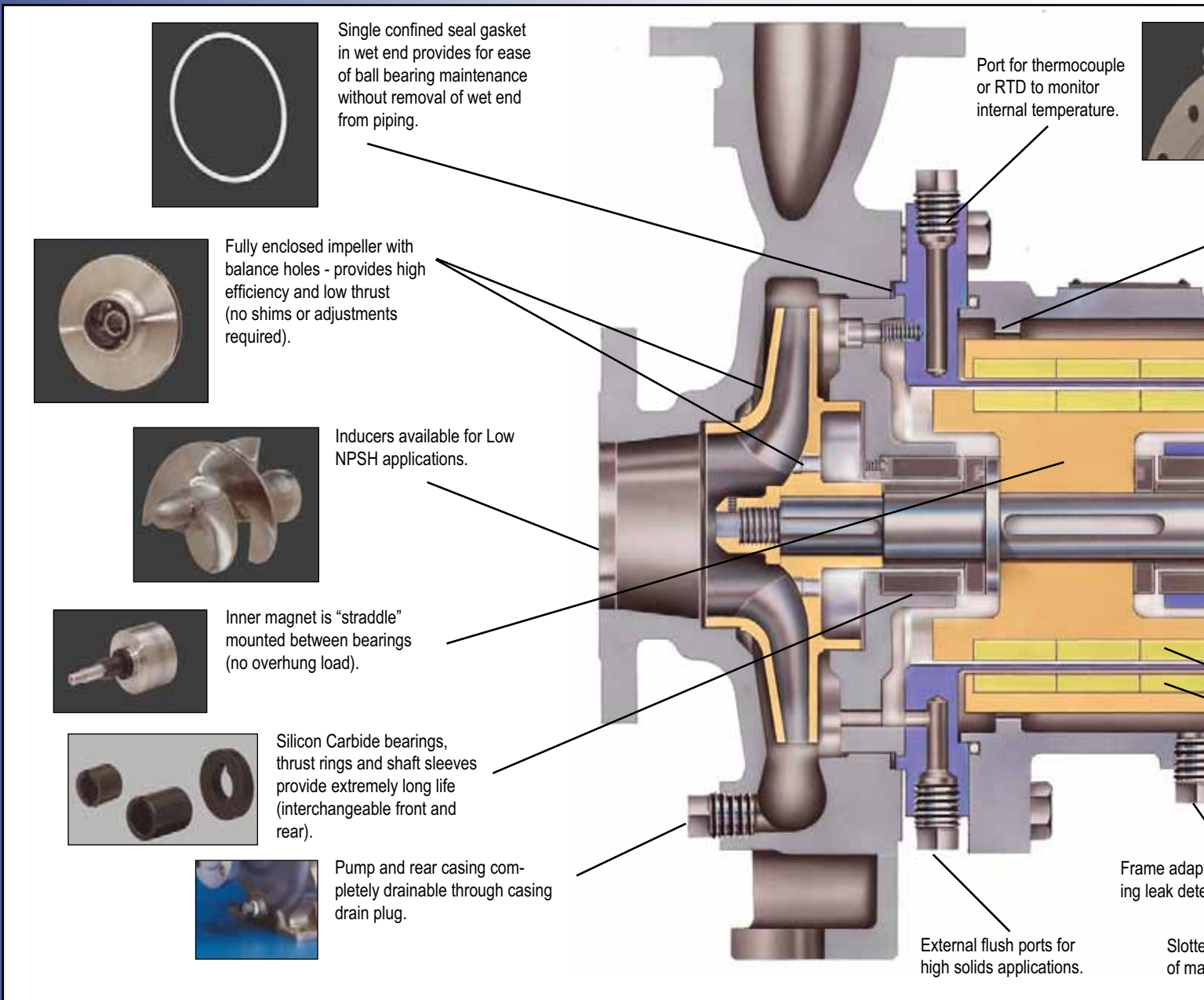

Reduced Bearing Wear

Magnatex design magnetic drive pumps exclusively utilize a straddle bearing design which significantly reduces bearing wear, lowers shaft loads and increases bearing life. Engineers familiar with how forces and moments are transmitted within a pump have long been aware that cantilevered (overhung) loads increase bending moments and stress levels.

Pictured is a comparison between the Magnatex straddle mount design and a typical overhung design. The solid red line illustrates static shaft deflections assuming similar impeller weight, magnet weight, shaft length and shaft diameter.

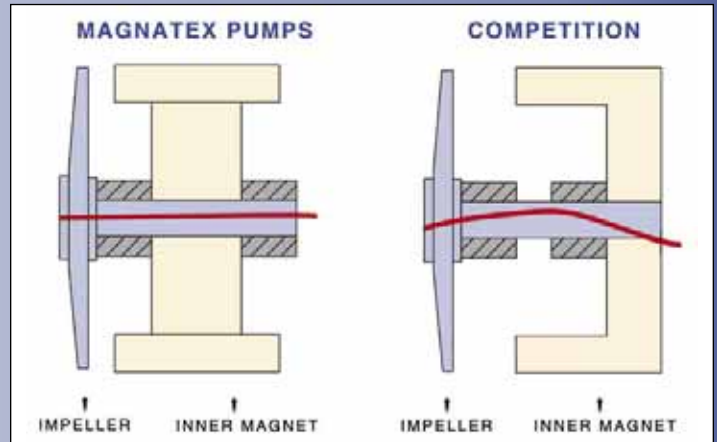

Anti-contact ribs prevent outer magnet from rubbing on rear casing, in the event ball bearings fail.

Large internal magnet radial clearance: 0.060" minimum.

Rugged Hastelloy C rear containment shell provides high efficiency and safe, positive hermetic sealing.

Optional high pressure secondary containment available.

Oil-lubricated bearings (easily adapted to oil mist). Grease-for-life bearings optional.

Cooling fins and ports on bearing frame.

Neodymium or Samarium Cobalt magnets provide synchronous drive (no slip).

1/2" tap on frame adapter for mounting vibration monitoring equipment.

Water port for mounting vibration monitor.

Mounting feet for ease of maintenance.

MPT Series/MPH Series

“A major North Carolina synthetic fiber facility experienced serious problems with column reflux pumps for a fluorinated fluid. Low flow, high TDH and scant NPSHa bedeviled every pump tried, until Magnatex MPT pumps were installed. Four years later, they continue to perform flawlessly.”

MPT Series Magnetically Driven, Sealless, Regenerative Turbine Vane Pumps

These Magnatex pumps are designed specifically for small flows at medium-to-high heads. The MPT Series features close-coupled construction similar to the MP Series, but uses a regenerative turbine vane impeller. This design provides efficient pump hydraulics even at very low flow rates.

MPT Series advantages include:

- Excellent vapor handling capability
- Steep head curve for system pressure swings with minimal change in flow
- 316 SS construction
- Higher heads and low flows



MPH Series Magnetically Driven, Sealless, High-Temperature Centrifugal Pumps

Designed for low-flow, high-head, high-temperature applications, MPH Series pumps save valuable space, eliminate alignment problems and reduce installation costs. Hydraulic performance is the same as MP Series pumps.

MPH Series benefits include:

- Finned frame adapter for highly effective heat dissipation
- No cooling water required
- Straddle-mounted, double bearing design reduces shaft load and bearing wear
- Slip-fit construction allows easy field repairs

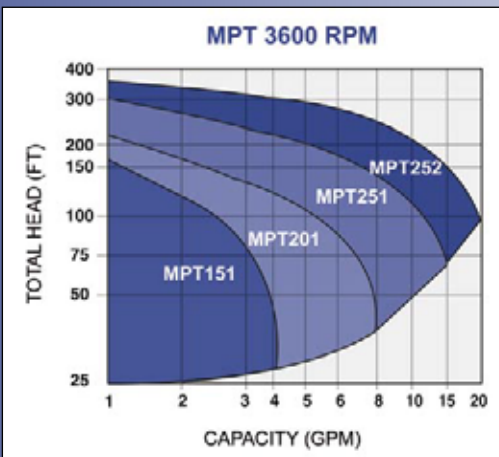

Specifications

	<u>MPT</u>	<u>MPH</u>
Maximum Flow	18 GPM	150 GPM
Maximum Head	340 FT	190 FT
Temperature	-40 to 300° F	-40 to 535° F
Maximum Power.....	5 HP	5 HP
Working Pressure.....	225 PSIG	150 PSIG
Materials of Construction.....	316 SS	316 SS
Connections	NPT or 150 LB RF	150 LB RF
Bearings	Silicon Carbide	Silicon Carbide
Impeller.....	Turbine Vane	Enclosed
Speeds	1800/3600 RPM	1800/3600 RPM
Magnets.....	Neodymium	Samarium Cobalt
Motor	“C” Face	“C” Face

MMP Series

MMP Series Magnetically Driven, Sealless, Centrifugal Pumps

These are heavy-duty mag-drive pumps with superior bearing materials.

These close-coupled pumps are similar in construction to their "big brothers," the Magnatex MPL/MP Series, except the shaft is stationary and the suction/discharge ports are male NPT with optional 150 LB RF flanges.

The MMP Series pumps are high-quality, dependable, long-lasting, heavy-duty pumps utilizing our exclusive straddle bearing design and furnished with shaft, thrust ring and bushings made of Beta sintered Silicon Carbide material.



MMP Specifications

Maximum Flow	20 GPM
Maximum Head95 FT
Temperature	-100 to 300° F
Maximum Power.....	¾ HP
Working Pressure.....	85 PSIG
Materials of Construction.....	316 SS
Connections	NPT or 150 LB RF
Bearings	Silicon Carbide
Impeller.....	Enclosed
Speeds	3600 RPM
Magnets.....	Neodymium
Motor	"C" Face

"Maintenance personnel at a large supplier of Hydrogen Peroxide found themselves replacing the carbon bearings in their inexpensive mag-drive pumps every 6 to 7 weeks. Tired of continual repairs, they decided to install a Magnatex MP Series mag-drive pump for a test. The Magnatex pump totally eliminated their repair costs to the delight of both maintenance and purchasing. They began replacing all of their sealless pumps with Magnatex."

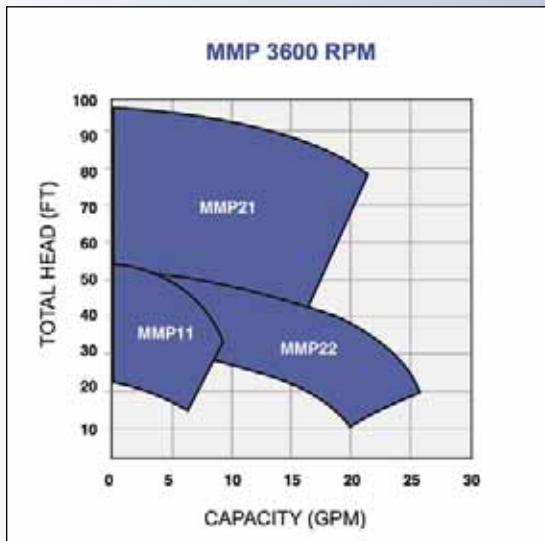

Magnatex®... your industry's answer

Magnatex Pumps, Inc. was established in 1985 to supply magnetically driven, sealless pumps to the process industry in response to growing concerns for the environment, the safety of plant personnel and the high cost of maintenance. Today there are thousands of these extremely reliable pumps installed in a wide variety of industries:

- | | | |
|--------------------------------|-----------------------|------------------------|
| Chemical Process | Food and Beverage | General Industrial |
| Water and Wastewater Treatment | Electronics | Aerospace |
| Pharmaceutical | Cosmetics | Steel |
| Textiles | OEM | Hydrocarbon Processing |
| Adhesives | Agricultural Chemical | Battery Manufacturing |
| Pulp and Paper | Packaging | Nuclear Power Plants |

Highly satisfied customers utilize these pumps in a wide variety of service from DI water to much more demanding applications including ethylene oxide, aqueous ammonia, solvents, concentrated acids, boiling caustic, formaldehyde and fluorinated hydrocarbons.

Magnatex[®] Service

Settle for nothing less than the best performing magnetic drive pumps in the world. Make it Magnatex.

For more information on additional Magnatex metallic and fluoropolymer lined magnetic drive pumps, just call, visit us online, or contact your authorized Magnatex representative.

Commitment to Excellence

Your return on investment in Magnatex pumps is assured by Magnatex's commitment to excellence in every phase of operations. From the moment we receive your initial inquiry to the completion of your project, you can be assured of our dedication to meeting your requirements in every respect. Our commitment to serving you with the best in magnetic pump design, fabrication and after-sale service never ends. We are dedicated to the philosophy of ensuring that our customers recover their investment in their Magnatex pumps many, many times over.

Capability "Outside the Box"

The standard products of tomorrow will be the result of solving today's pumping problems with engineering innovation based on broad application experience. Magnatex and its worldwide partners offer the capability to address application challenges well beyond the standard product range described in this bulletin and welcome inquiries soliciting solutions to unresolved pumping problems.



Your Local Representative:

Customer Support

Benefits assuring Magnatex customers 100% satisfaction include:

- A nationwide network of technical sales and service representatives
- Start-up engineering assistance
- On-site training available nationwide for customers' operations and maintenance personnel
- A computerized pump selection program designed specifically for magnetic drive pump applications
- Extensive inventory of pumps and replacement parts to assure immediate response to customers' emergency needs—24 hours a day



Magnatex Pumps, Inc.
3575 West 12th Street
Houston, TX 77008
Phone (713) 972-8666
Toll-free (866) MAG-PUMP
Fax (713) 972-8665
Email: sales@magnatexpumps.com
www.magnatexpumps.com